

BC817; BC817W; BC337

45 V, 500 mA NPN general-purpose transistors

Rev. 06 — 17 November 2009

Product data sheet

1. Product profile

1.1 General description

NPN general-purpose transistors.

Table 1. Product overview

Type number	Package		PNP complement
	NXP	JEITA	
BC817	SOT23	-	BC807
BC817W	SOT323	SC-70	BC807W
BC337 ^[1]	SOT54 (TO-92)	SC-43A	BC327

[1] Also available in SOT54A and SOT54 variant packages (see [Section 2](#)).

1.2 Features

- High current
- Low voltage

1.3 Applications

- General-purpose switching and amplification

1.4 Quick reference data

Table 2. Quick reference data

Symbol	Parameter	Conditions	Min	Typ	Max	Unit
V_{CE0}	collector-emitter voltage	open base; $I_C = 10 \text{ mA}$	-	-	45	V
I_C	collector current (DC)		-	-	500	mA
I_{CM}	peak collector current		-	-	1	A
h_{FE}	DC current gain	$I_C = 100 \text{ mA};$ $V_{CE} = 1 \text{ V}$	^[1]	-	-	-
	BC817; BC817W; BC337			100	-	600
	BC817-16; BC817-16W; BC337-16			100	-	250
	BC817-25; BC817-25W; BC337-25			160	-	400
	BC817-40; BC817-40W; BC337-40			250	-	600

[1] Pulse test: $t_p \leq 300 \mu\text{s}$; $\delta \leq 0.02$.

2. Pinning information

Table 3. Pinning

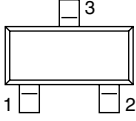
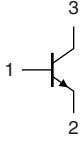
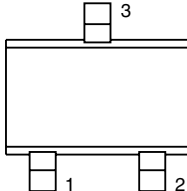
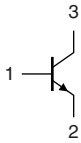
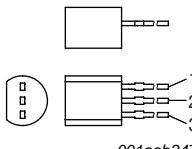
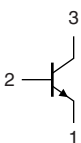
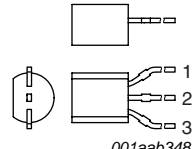
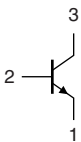
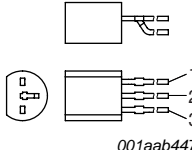
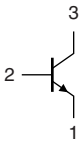
Pin	Description	Simplified outline	Symbol
SOT23			
1	base		 sym021
2	emitter		
3	collector		
SOT323			
1	base	 sot323_so	 sym021
2	emitter		
3	collector		
SOT54			
1	emitter	 001aab347	 sym026
2	base		
3	collector		
SOT54A			
1	emitter	 001aab348	 sym026
2	base		
3	collector		
SOT54 variant			
1	emitter	 001aab447	 sym026
2	base		
3	collector		

3. Ordering information

Table 4. Ordering information

Type number ^[1]	Package		
	Name	Description	Version
BC817	-	plastic surface mounted package; 3 leads	SOT23
BC817W	SC-70	plastic surface mounted package; 3 leads	SOT323
BC337 ^[2]	SC-43A	plastic single-ended leaded (through hole) package; 3 leads	SOT54

[1] Valid for all available selection groups.

[2] Also available in SOT54A and SOT54 variant packages (see [Section 2](#) and [Section 9](#)).

4. Marking

Table 5. Marking codes

Type number	Marking code ^[1]
BC817	6D*
BC817-16	6A*
BC817-25	6B*
BC817-40	6C*
BC817W	6D*
BC817-16W	6A*
BC817-25W	6B*
BC817-40W	6C*
BC337	C337
BC337-16	C33716
BC337-25	C33725
BC337-40	C33740

[1] * = -: made in Hong Kong
 * = p: made in Hong Kong
 * = t: made in Malaysia
 * = W: made in China

5. Limiting values

Table 6. Limiting values

In accordance with the Absolute Maximum Rating System (IEC 60134).

Symbol	Parameter	Conditions	Min	Max	Unit	
V_{CBO}	collector-base voltage	open emitter	-	50	V	
V_{CEO}	collector-emitter voltage	open base; $I_C = 10\text{ mA}$	-	45	V	
V_{EBO}	emitter-base voltage	open collector	-	5	V	
I_C	collector current (DC)		-	500	mA	
I_{CM}	peak collector current		-	1	A	
I_{BM}	peak base current		-	200	mA	
P_{tot}	total power dissipation					
	BC817	$T_{amb} \leq 25\text{ °C}$	[1][2]	-	250	mW
	BC817W	$T_{amb} \leq 25\text{ °C}$	[1][2]	-	200	mW
	BC337	$T_{amb} \leq 25\text{ °C}$	[1][2]	-	625	mW
T_{stg}	storage temperature		-65	+150	°C	
T_j	junction temperature		-	150	°C	
T_{amb}	ambient temperature		-65	+150	°C	

[1] Transistor mounted on an FR4 printed-circuit board, single-sided copper, tin-plated and standard footprint.

[2] Valid for all available selection groups.

6. Thermal characteristics

Table 7. Thermal characteristics

Symbol	Parameter	Conditions	Min	Typ	Max	Unit
$R_{th(j-a)}$	thermal resistance from junction to ambient					
	BC817	$T_{amb} \leq 25\text{ °C}$	[1][2]	-	500	K/W
	BC817W	$T_{amb} \leq 25\text{ °C}$	[1][2]	-	625	K/W
	BC337	$T_{amb} \leq 25\text{ °C}$	[1][2]	-	200	K/W

[1] Transistor mounted on an FR4 printed-circuit board, single-sided copper, tin-plated and standard footprint.

[2] Valid for all available selection groups.

7. Characteristics

Table 8. Characteristics

$T_{amb} = 25\text{ °C}$ unless otherwise specified.

Symbol	Parameter	Conditions	Min	Typ	Max	Unit
I_{CBO}	collector-base cut-off current	$I_E = 0\text{ A}; V_{CB} = 20\text{ V}$	-	-	100	nA
		$I_E = 0\text{ A}; V_{CB} = 20\text{ V};$ $T_j = 150\text{ °C}$	-	-	5	μA
I_{EBO}	emitter-base cut-off current	$I_C = 0\text{ A}; V_{EB} = 5\text{ V}$	-	-	100	nA
h_{FE}	DC current gain	$I_C = 100\text{ mA}; V_{CE} = 1\text{ V}$	[1]			
			BC817; BC817W; BC337	100	-	600
			BC817-16; BC817-16W; BC337-16	100	-	250
			BC817-25; BC817-25W; BC337-25	160	-	400
	BC817-40; BC817-40W; BC337-40	250	-	600		
h_{FE}	DC current gain	$I_C = 500\text{ mA}; V_{CE} = 1\text{ V}$	[1] 40	-	-	
V_{CEsat}	collector-emitter saturation voltage	$I_C = 500\text{ mA}; I_B = 50\text{ mA}$	[1] -	-	700	mV
V_{BE}	base-emitter voltage	$I_C = 500\text{ mA}; V_{CE} = 1\text{ V}$	[2] -	-	1.2	V
C_c	collector capacitance	$I_E = i_e = 0\text{ A}; V_{CB} = 10\text{ V};$ $f = 1\text{ MHz}$	-	3	-	pF
f_T	transition frequency	$I_C = 10\text{ mA}; V_{CE} = 5\text{ V};$ $f = 100\text{ MHz}$	100	-	-	MHz

[1] Pulse test: $t_p \leq 300\text{ }\mu\text{s}; \delta \leq 0.02$.

[2] V_{BE} decreases by approximately 2 mV/K with increasing temperature.

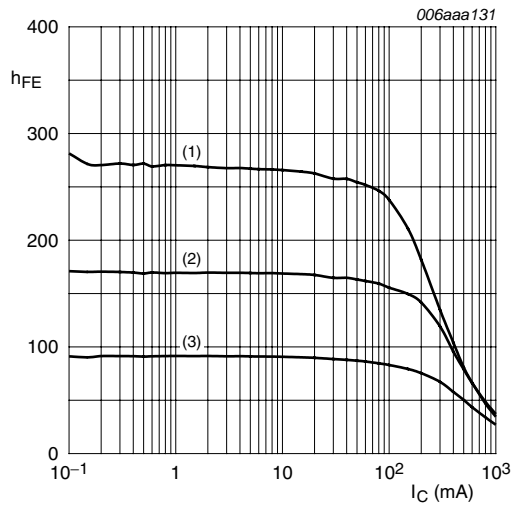

$V_{CE} = 1\text{ V}$
 (1) $T_{amb} = 150\text{ °C}$
 (2) $T_{amb} = 25\text{ °C}$
 (3) $T_{amb} = -55\text{ °C}$

Fig 1. Selection -16: DC current gain as a function of collector current; typical values

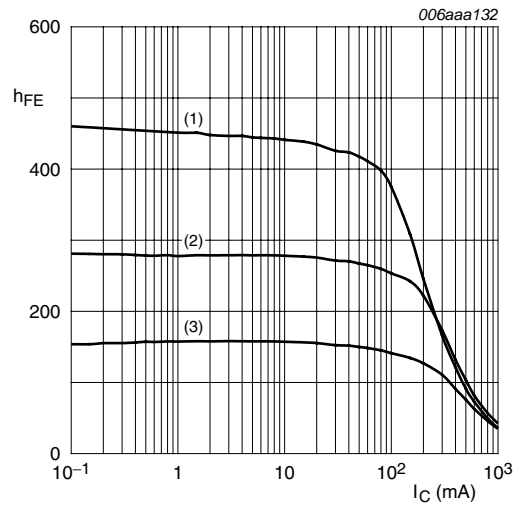

$V_{CE} = 1\text{ V}$
 (1) $T_{amb} = 150\text{ °C}$
 (2) $T_{amb} = 25\text{ °C}$
 (3) $T_{amb} = -55\text{ °C}$

Fig 2. Selection -25: DC current gain as a function of collector current; typical values

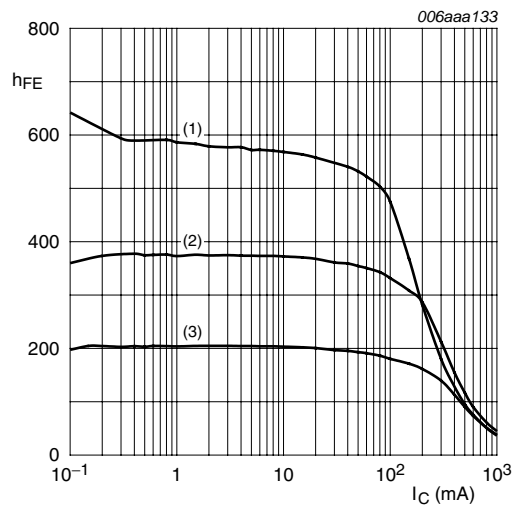

$V_{CE} = 1\text{ V}$
 (1) $T_{amb} = 150\text{ °C}$
 (2) $T_{amb} = 25\text{ °C}$
 (3) $T_{amb} = -55\text{ °C}$

Fig 3. Selection -40: DC current gain as a function of collector current; typical values

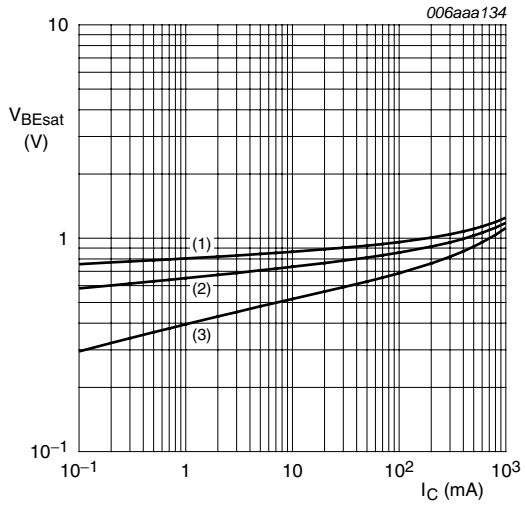

- $I_C/I_B = 10$
- (1) $T_{amb} = -55\text{ °C}$
 - (2) $T_{amb} = 25\text{ °C}$
 - (3) $T_{amb} = 150\text{ °C}$

Fig 4. Selection -16: Base-emitter saturation voltage as a function of collector current; typical values

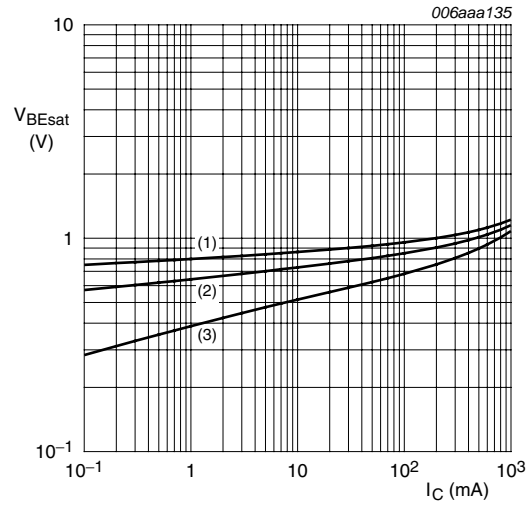

- $I_C/I_B = 10$
- (1) $T_{amb} = -55\text{ °C}$
 - (2) $T_{amb} = 25\text{ °C}$
 - (3) $T_{amb} = 150\text{ °C}$

Fig 5. Selection -25: Base-emitter saturation voltage as a function of collector current; typical values

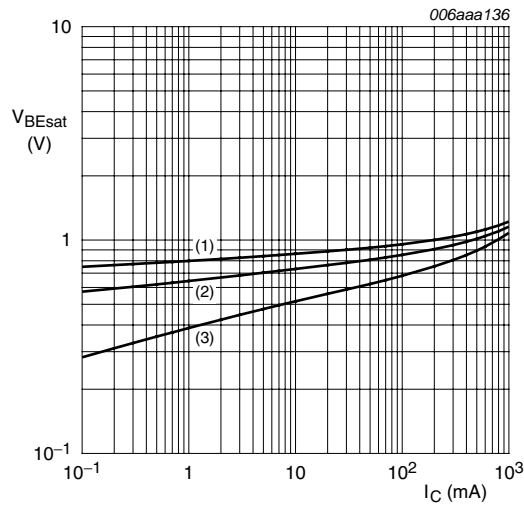

- $I_C/I_B = 10$
- (1) $T_{amb} = -55\text{ °C}$
 - (2) $T_{amb} = 25\text{ °C}$
 - (3) $T_{amb} = 150\text{ °C}$

Fig 6. Selection -40: Base-emitter saturation voltage as a function of collector current; typical values

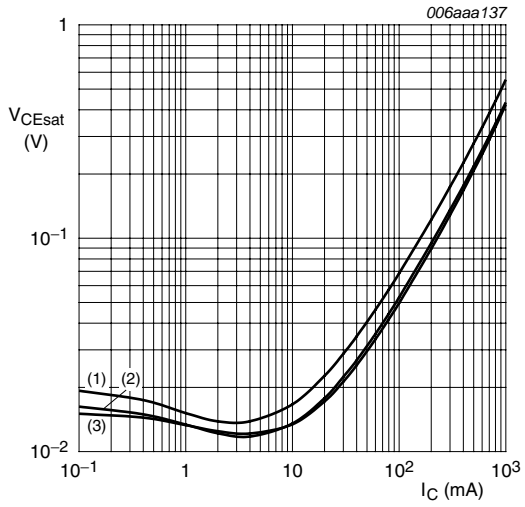

- $I_C/I_B = 10$
- (1) $T_{amb} = 150\text{ °C}$
 - (2) $T_{amb} = 25\text{ °C}$
 - (3) $T_{amb} = -55\text{ °C}$

Fig 7. Selection -16: Collector-emitter saturation voltage as a function of collector current; typical values

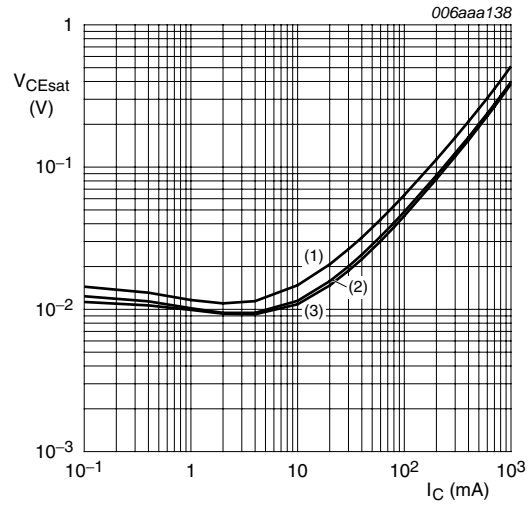

- $I_C/I_B = 10$
- (1) $T_{amb} = 150\text{ °C}$
 - (2) $T_{amb} = 25\text{ °C}$
 - (3) $T_{amb} = -55\text{ °C}$

Fig 8. Selection -25: Collector-emitter saturation voltage as a function of collector current; typical values

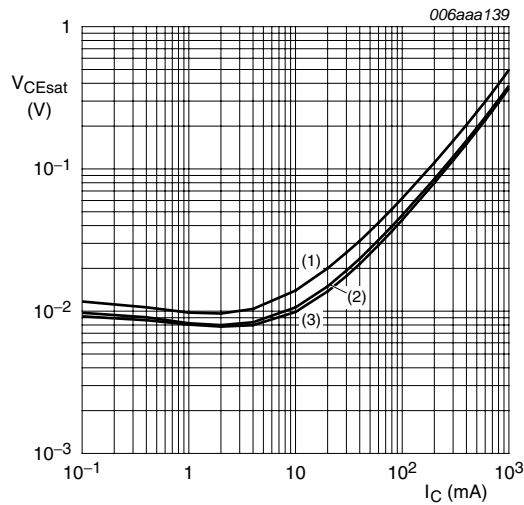

- $I_C/I_B = 10$
- (1) $T_{amb} = 150\text{ °C}$
 - (2) $T_{amb} = 25\text{ °C}$
 - (3) $T_{amb} = -55\text{ °C}$

Fig 9. Selection -40: Collector-emitter saturation voltage as a function of collector current; typical values

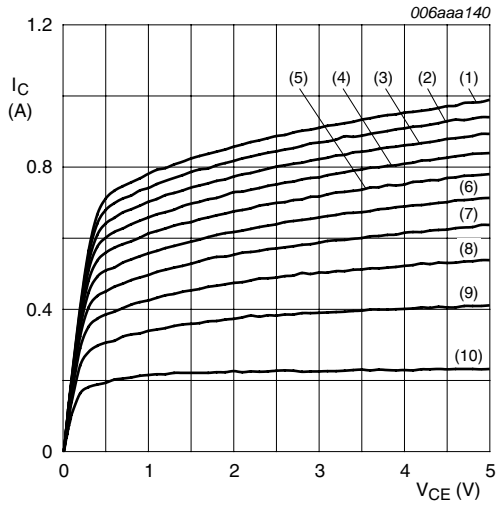

- $T_{amb} = 25\text{ }^\circ\text{C}$
- (1) $I_B = 16.0\text{ mA}$
 - (2) $I_B = 14.4\text{ mA}$
 - (3) $I_B = 12.8\text{ mA}$
 - (4) $I_B = 11.2\text{ mA}$
 - (5) $I_B = 9.6\text{ mA}$
 - (6) $I_B = 8.0\text{ mA}$
 - (7) $I_B = 6.4\text{ mA}$
 - (8) $I_B = 4.8\text{ mA}$
 - (9) $I_B = 3.2\text{ mA}$
 - (10) $I_B = 1.6\text{ mA}$

Fig 10. Selection -16: Collector current as a function of collector-emitter voltage; typical values

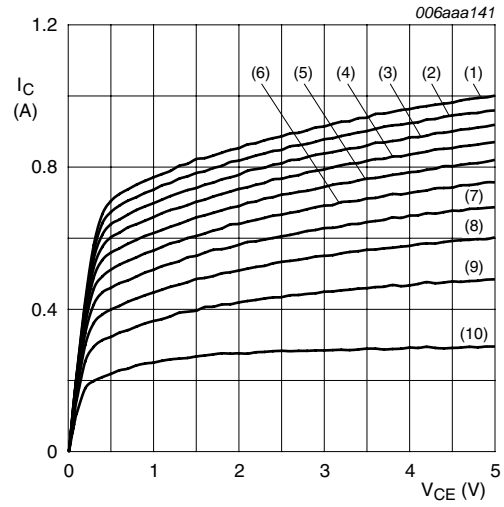

- $T_{amb} = 25\text{ }^\circ\text{C}$
- (1) $I_B = 13.0\text{ mA}$
 - (2) $I_B = 11.7\text{ mA}$
 - (3) $I_B = 10.4\text{ mA}$
 - (4) $I_B = 9.1\text{ mA}$
 - (5) $I_B = 7.8\text{ mA}$
 - (6) $I_B = 6.5\text{ mA}$
 - (7) $I_B = 5.2\text{ mA}$
 - (8) $I_B = 3.9\text{ mA}$
 - (9) $I_B = 2.6\text{ mA}$
 - (10) $I_B = 1.3\text{ mA}$

Fig 11. Selection -25: Collector current as a function of collector-emitter voltage; typical values

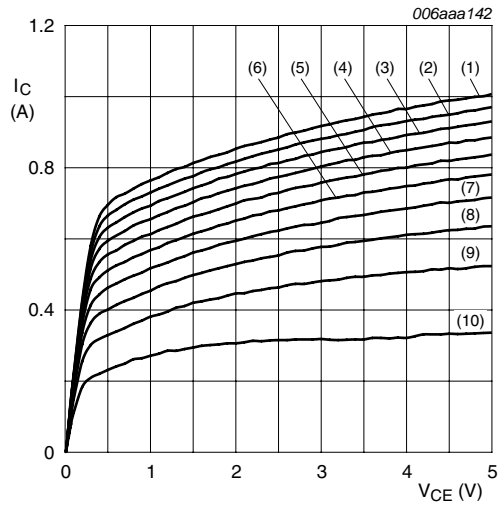

$T_{amb} = 25\text{ }^{\circ}\text{C}$

- (1) $I_B = 12.0\text{ mA}$
- (2) $I_B = 10.8\text{ mA}$
- (3) $I_B = 9.6\text{ mA}$
- (4) $I_B = 8.4\text{ mA}$
- (5) $I_B = 7.2\text{ mA}$
- (6) $I_B = 6.0\text{ mA}$
- (7) $I_B = 4.8\text{ mA}$
- (8) $I_B = 3.6\text{ mA}$
- (9) $I_B = 2.4\text{ mA}$
- (10) $I_B = 1.2\text{ mA}$

Fig 12. Selection -40: Collector current as a function of collector-emitter voltage; typical values

8. Package outline

Plastic surface-mounted package; 3 leads

SOT23

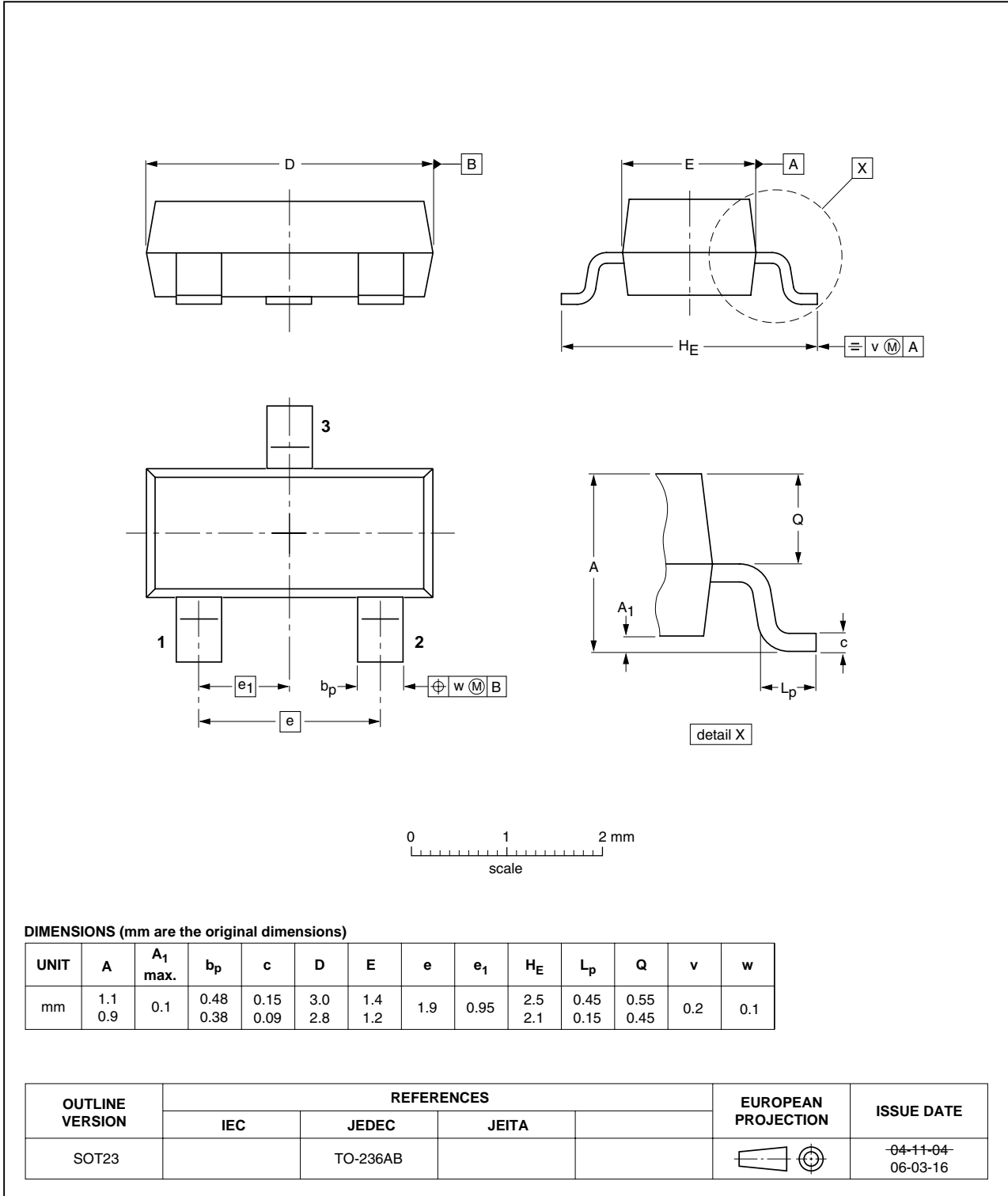

Fig 13. Package outline SOT23 (TO-236AB)

Plastic surface-mounted package; 3 leads

SOT323

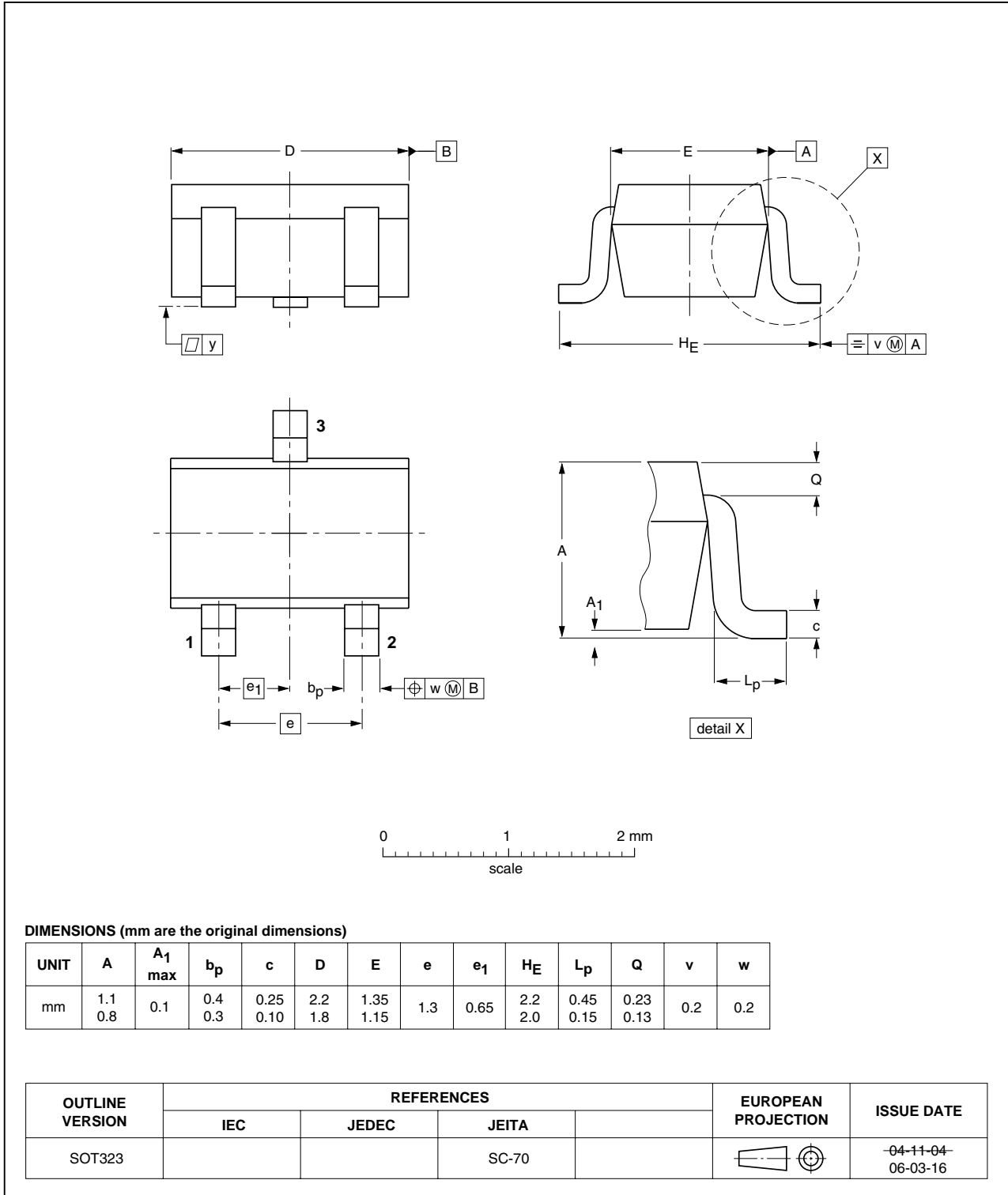

Fig 14. Package outline SOT323 (SC-70)

Plastic single-ended leaded (through hole) package; 3 leads

SOT54

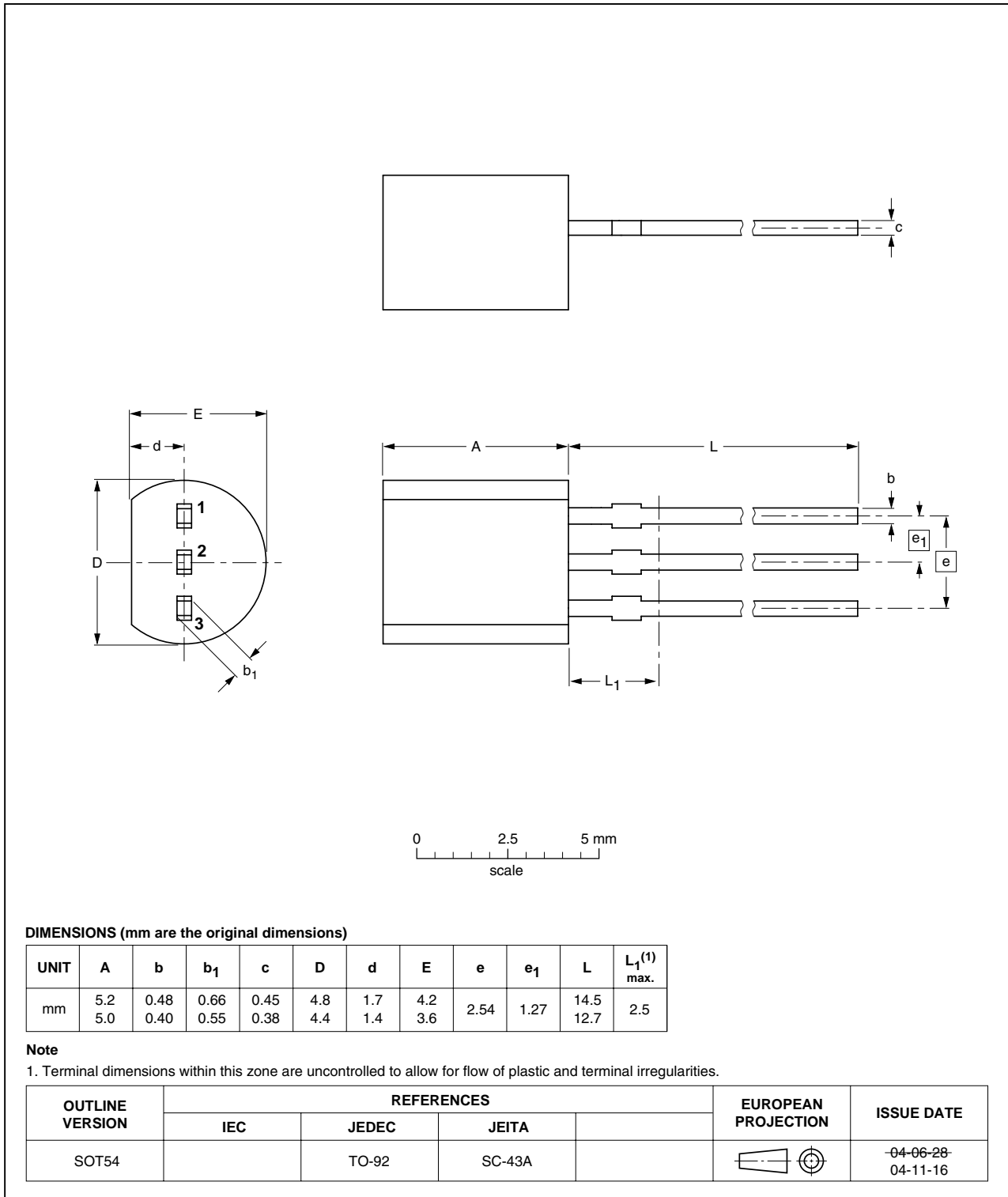

Fig 15. Package outline SOT54 (SC-43A/TO-92)

Plastic single-ended leaded (through hole) package; 3 leads (wide pitch)

SOT54A

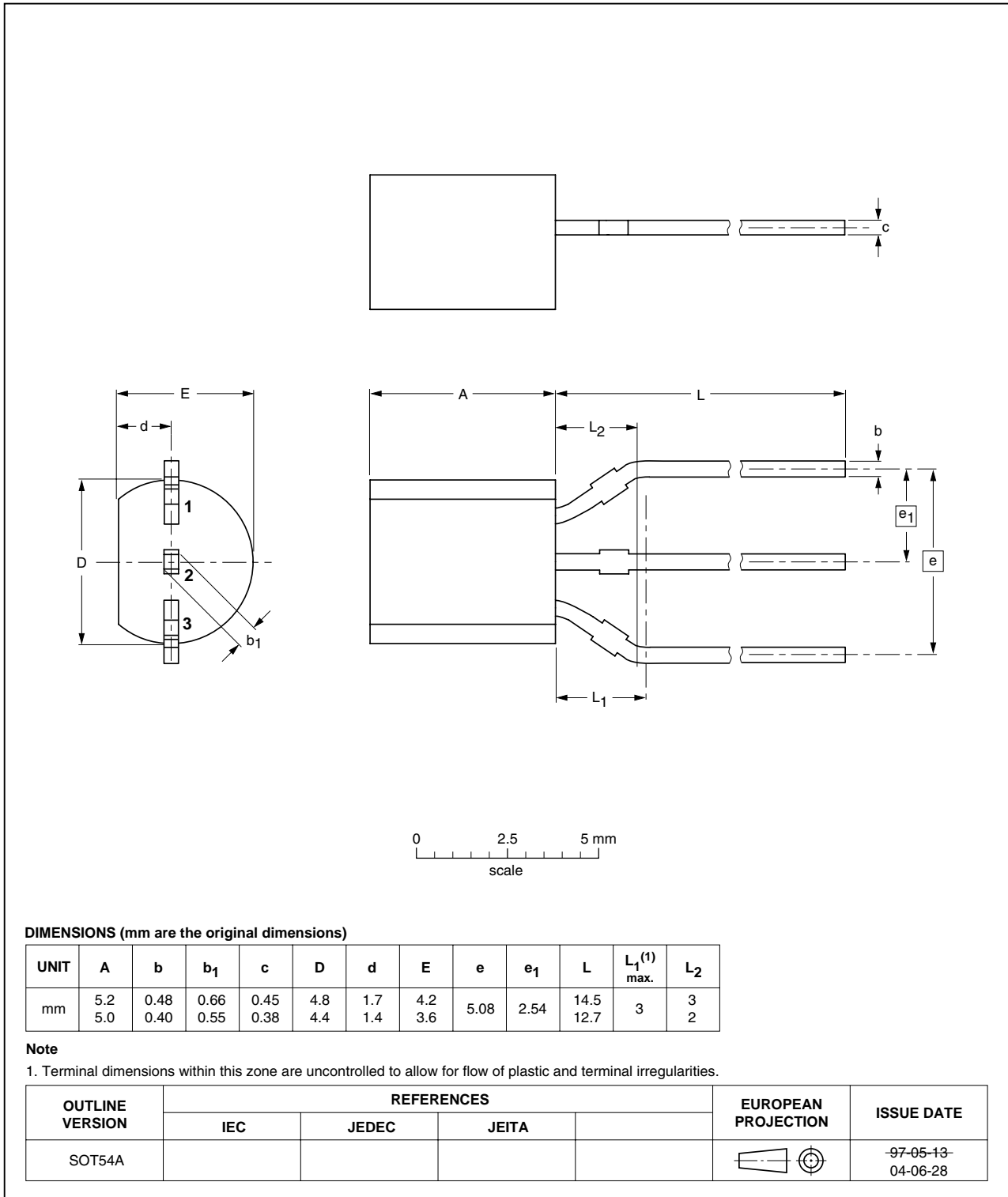

Fig 16. Package outline SOT54A

Plastic single-ended leaded (through hole) package; 3 leads (on-circle)

SOT54 variant

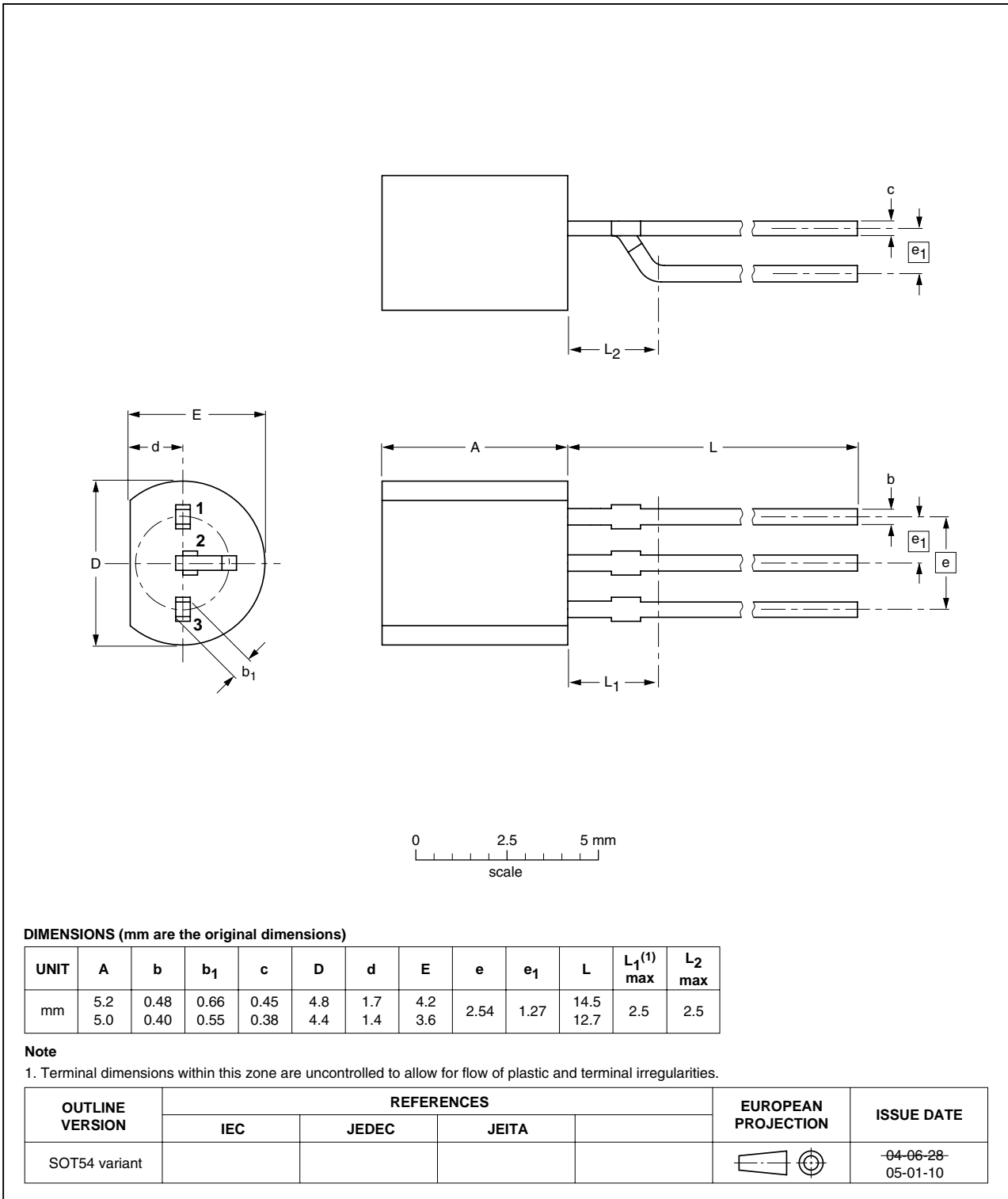

Fig 17. Package outline SOT54 variant

9. Packing information

Table 9. Packing methods

The indicated -xxx are the last three digits of the 12NC ordering code.^[1]

Type number	Package	Description	Packing quantity		
			3000	5000	10000
BC817	SOT23	4 mm pitch, 8 mm tape and reel	-215	-	-235
BC817W	SOT323	4 mm pitch, 8 mm tape and reel	-115	-	-135
BC337	SOT54	bulk, straight leads	-	-412	-
BC337	SOT54A	tape and reel, wide pitch	-	-	-116
BC337	SOT54A	tape ammopack, wide pitch	-	-	-126
BC337	SOT 54 variant	bulk, delta pinning (on-circle)	-	-112	-

[1] For further information and the availability of packing methods, see [Section 12](#).

10. Revision history

Table 10. Revision history

Document ID	Release date	Data sheet status	Change notice	Supersedes
BC817_BC817W_ BC337_6	20091117	Product data sheet	-	BC817_BC817W_ BC337_5
Modifications:		<ul style="list-style-type: none"> This data sheet was changed to reflect the new company name NXP Semiconductors, including new legal definitions and disclaimers. No changes were made to the technical content. Table 3 "Pinning": updated Figure 13 "Package outline SOT23 (TO-236AB)": updated Figure 14 "Package outline SOT323 (SC-70)": updated 		
BC817_BC817W_ BC337_5	20050121	Product data sheet	CPCN200302007F1	BC817_4; BC817W_SER_4; BC337_3
BC817_4	20040105	Product specification	-	BC817_3
BC817W_SER_4	20040225	Product specification	-	BC817W_SER_3
BC337_3	19990415	Product specification	-	BC337_338_CNV_2

11. Legal information

11.1 Data sheet status

Document status ^{[1][2]}	Product status ^[3]	Definition
Objective [short] data sheet	Development	This document contains data from the objective specification for product development.
Preliminary [short] data sheet	Qualification	This document contains data from the preliminary specification.
Product [short] data sheet	Production	This document contains the product specification.

[1] Please consult the most recently issued document before initiating or completing a design.

[2] The term 'short data sheet' is explained in section "Definitions".

[3] The product status of device(s) described in this document may have changed since this document was published and may differ in case of multiple devices. The latest product status information is available on the Internet at URL <http://www.nxp.com>.

11.2 Definitions

Draft — The document is a draft version only. The content is still under internal review and subject to formal approval, which may result in modifications or additions. NXP Semiconductors does not give any representations or warranties as to the accuracy or completeness of information included herein and shall have no liability for the consequences of use of such information.

Short data sheet — A short data sheet is an extract from a full data sheet with the same product type number(s) and title. A short data sheet is intended for quick reference only and should not be relied upon to contain detailed and full information. For detailed and full information see the relevant full data sheet, which is available on request via the local NXP Semiconductors sales office. In case of any inconsistency or conflict with the short data sheet, the full data sheet shall prevail.

11.3 Disclaimers

General — Information in this document is believed to be accurate and reliable. However, NXP Semiconductors does not give any representations or warranties, expressed or implied, as to the accuracy or completeness of such information and shall have no liability for the consequences of use of such information.

Right to make changes — NXP Semiconductors reserves the right to make changes to information published in this document, including without limitation specifications and product descriptions, at any time and without notice. This document supersedes and replaces all information supplied prior to the publication hereof.

Suitability for use — NXP Semiconductors products are not designed, authorized or warranted to be suitable for use in medical, military, aircraft, space or life support equipment, nor in applications where failure or malfunction of an NXP Semiconductors product can reasonably be expected to result in personal injury, death or severe property or environmental

damage. NXP Semiconductors accepts no liability for inclusion and/or use of NXP Semiconductors products in such equipment or applications and therefore such inclusion and/or use is at the customer's own risk.

Applications — Applications that are described herein for any of these products are for illustrative purposes only. NXP Semiconductors makes no representation or warranty that such applications will be suitable for the specified use without further testing or modification.

Limiting values — Stress above one or more limiting values (as defined in the Absolute Maximum Ratings System of IEC 60134) may cause permanent damage to the device. Limiting values are stress ratings only and operation of the device at these or any other conditions above those given in the Characteristics sections of this document is not implied. Exposure to limiting values for extended periods may affect device reliability.

Terms and conditions of sale — NXP Semiconductors products are sold subject to the general terms and conditions of commercial sale, as published at <http://www.nxp.com/profile/terms>, including those pertaining to warranty, intellectual property rights infringement and limitation of liability, unless explicitly otherwise agreed to in writing by NXP Semiconductors. In case of any inconsistency or conflict between information in this document and such terms and conditions, the latter will prevail.

No offer to sell or license — Nothing in this document may be interpreted or construed as an offer to sell products that is open for acceptance or the grant, conveyance or implication of any license under any copyrights, patents or other industrial or intellectual property rights.

Export control — This document as well as the item(s) described herein may be subject to export control regulations. Export might require a prior authorization from national authorities.

Quick reference data — The Quick reference data is an extract of the product data given in the Limiting values and Characteristics sections of this document, and as such is not complete, exhaustive or legally binding.

11.4 Trademarks

Notice: All referenced brands, product names, service names and trademarks are the property of their respective owners.

12. Contact information

For more information, please visit: <http://www.nxp.com>

For sales office addresses, please send an email to: salesaddresses@nxp.com

13. Contents

1	Product profile	1
1.1	General description	1
1.2	Features	1
1.3	Applications	1
1.4	Quick reference data	1
2	Pinning information	2
3	Ordering information	3
4	Marking	3
5	Limiting values	4
6	Thermal characteristics	4
7	Characteristics	5
8	Package outline	11
9	Packing information	16
10	Revision history	17
11	Legal information	18
11.1	Data sheet status	18
11.2	Definitions	18
11.3	Disclaimers	18
11.4	Trademarks	18
12	Contact information	18
13	Contents	19

Please be aware that important notices concerning this document and the product(s) described herein, have been included in section 'Legal information'.



© NXP B.V. 2009.

All rights reserved.

For more information, please visit: <http://www.nxp.com>

For sales office addresses, please send an email to: salesaddresses@nxp.com

Date of release: 17 November 2009

Document identifier: BC817_BC817W_BC337_6

www.s-manuals.com